

Cats Are Tailors

Mahir Wu - 2017.7 © (Revised-2018.10)

测验须知：

- 本测验共 40 道题。每题一分，在特定情况下可能赋予 0.5 分。
- 每道题都只有一个解，请选择一个**最简洁严谨**的解作为你的答案。
- 题目的难度大致随题号增加，但并不绝对。
- 为了得到比较公正的分数，请**独立**完成本测验，不要和他人讨论本测验的题目。
- 本测验允许多次提交，但是只有前**两次**有认可效力。
- 如果你认为某道题答案不唯一，你可以提交两个答案，但两个答案都需要附上详细的逻辑解释。
- 本测试批改费用为**每次 70 人民币/12 美元/10 欧元**，支付到我的支付宝账号 **mahirwu@qq.com**。
- 做完测验后，将提交表.xls（可使用中文填表）和测试答案一并提交到我的邮箱 **mahirwu@qq.com**，我会在十五天内批改并回复。

注意：

以下两种提交方式二选一。

(a) 如果仅提交答案，请注意以下几点。

- 如果答题框内含有阵点，答案中需要保留那些阵点。
- 答题框可以不画，也可以画成矩形框，但不能影响里面的答案。
- 答案应是题目答题框中缺失的部分。
- 答案请简洁且完整。
- **建议下载 CAT 专用答题纸进行答题。**

(b) 如果将答案填补到题干中一并提交，则注意题干整体的完备性即可。

Example one:

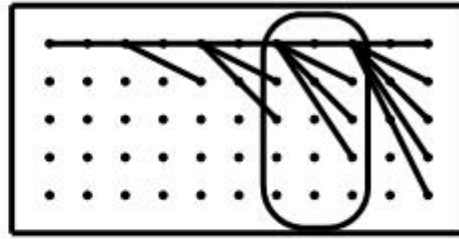
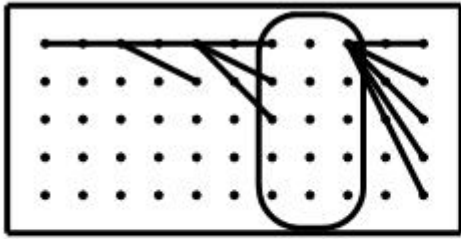

Right



Right



Wrong

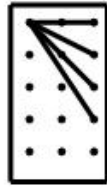

Right



Wrong



Wrong

Example two:

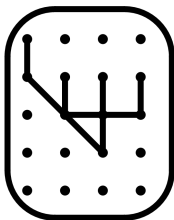
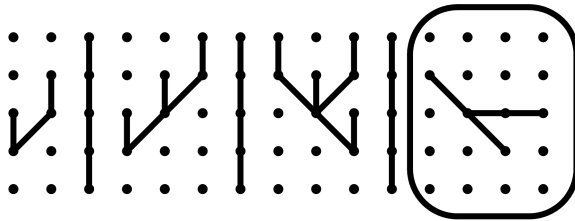

Right

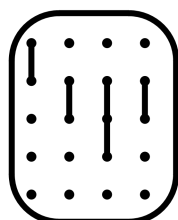

Wrong

The formal test questions

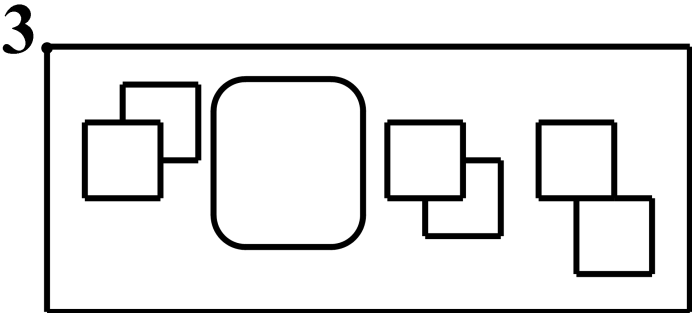
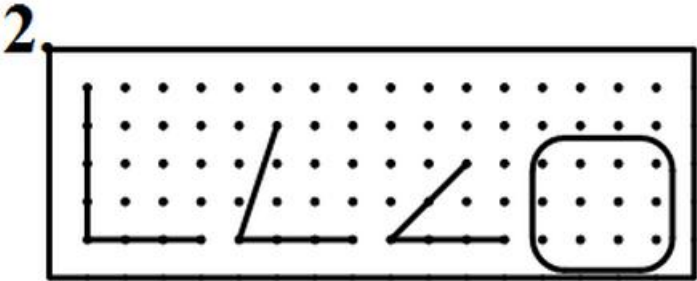
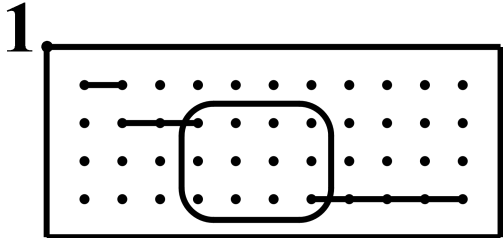

4

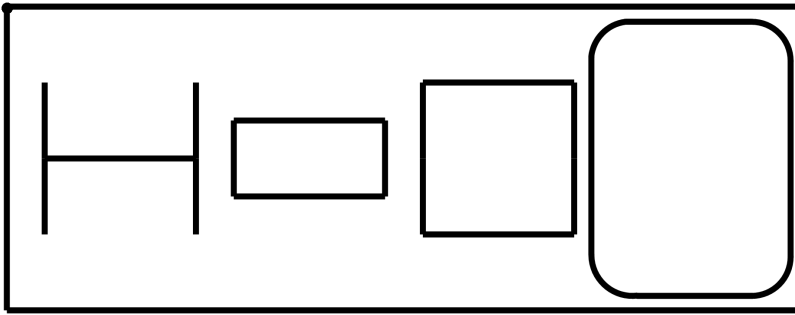

5

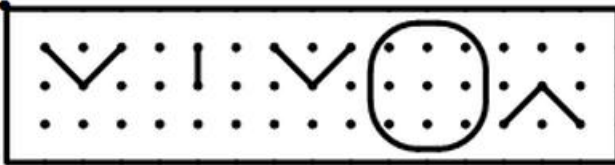

6

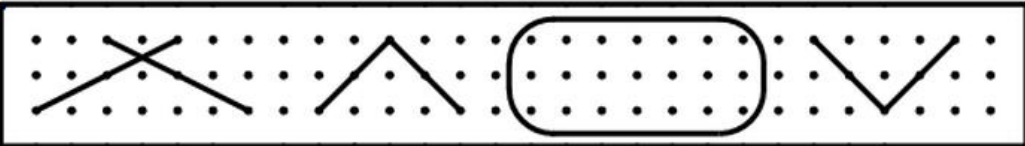

7

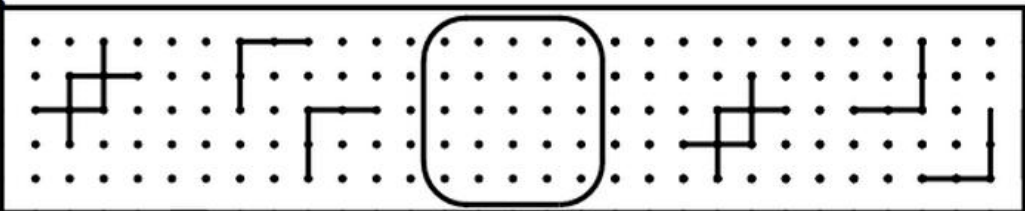

8

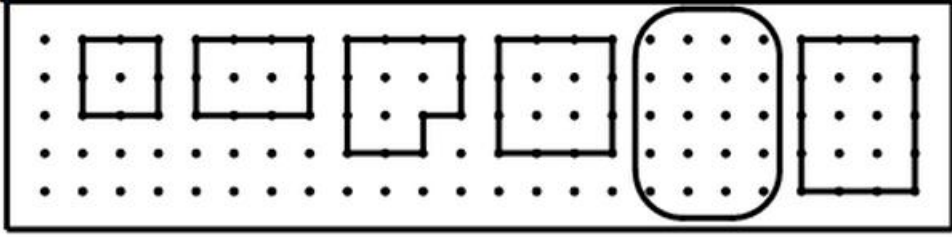

9

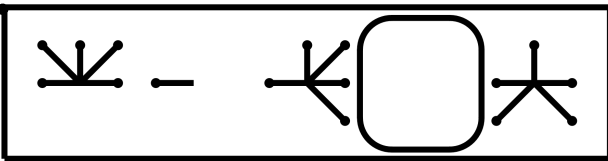

10.

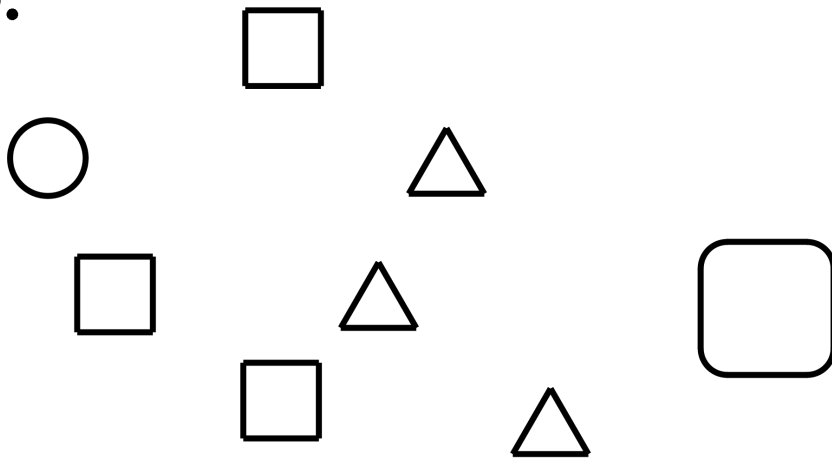

11

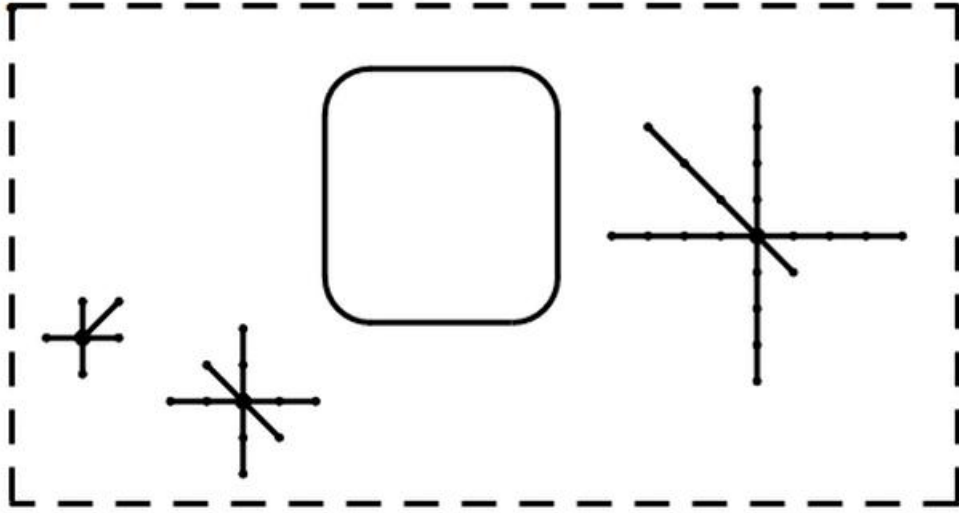

12

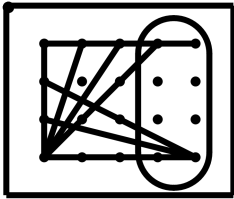

13

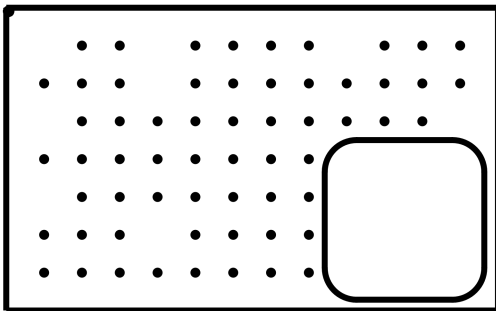

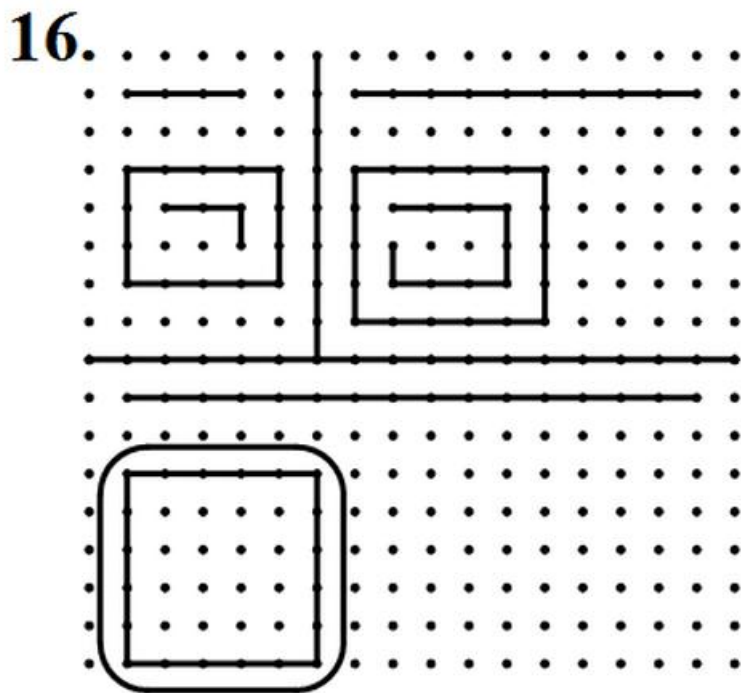
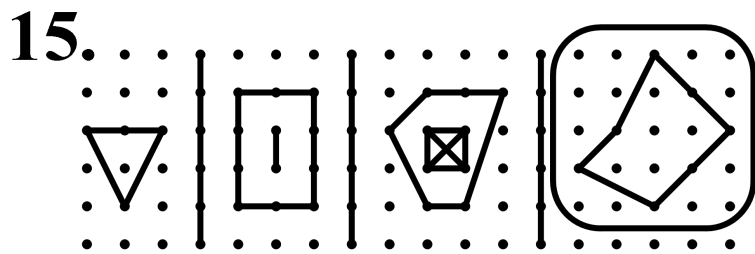
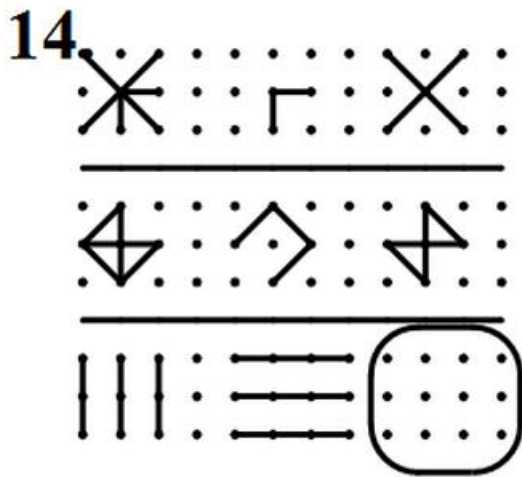

17.

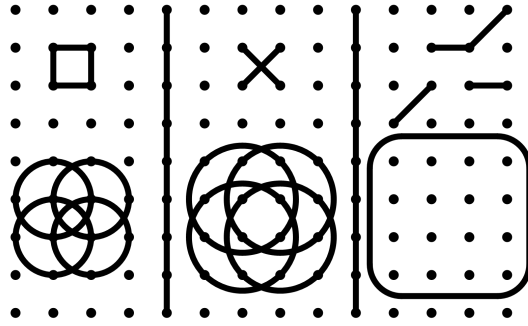

18

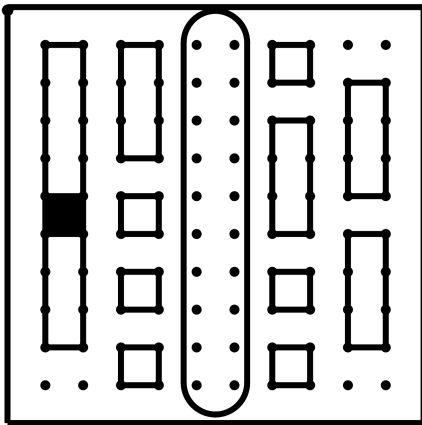

19

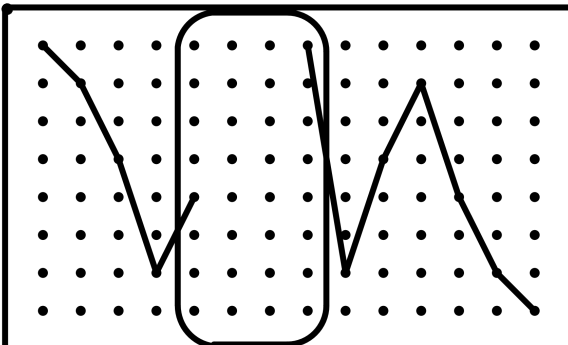

20

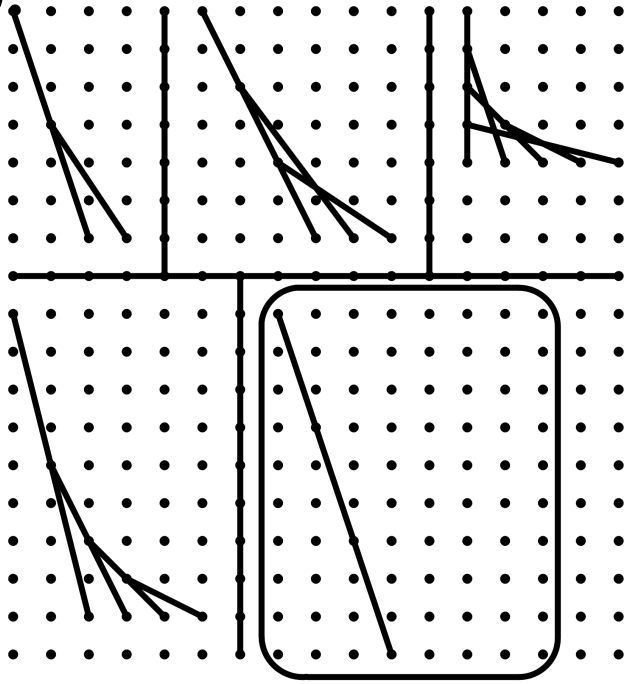

21.

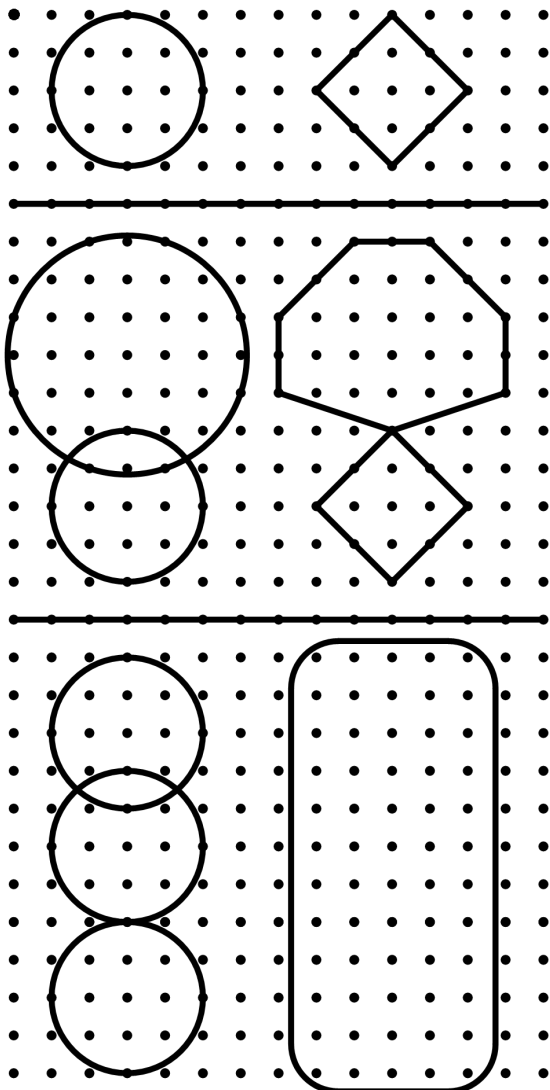

22

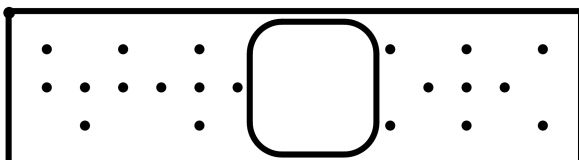

23.

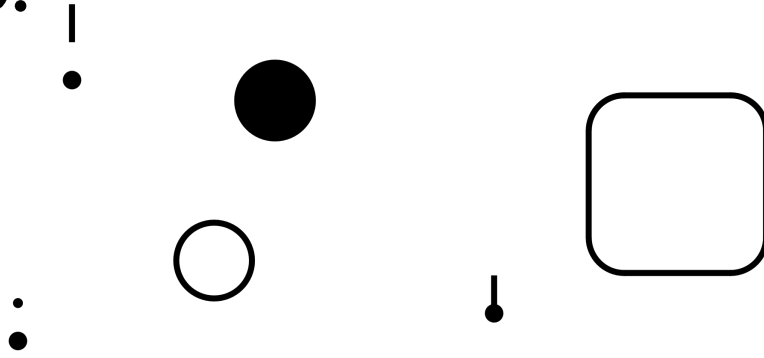

24.

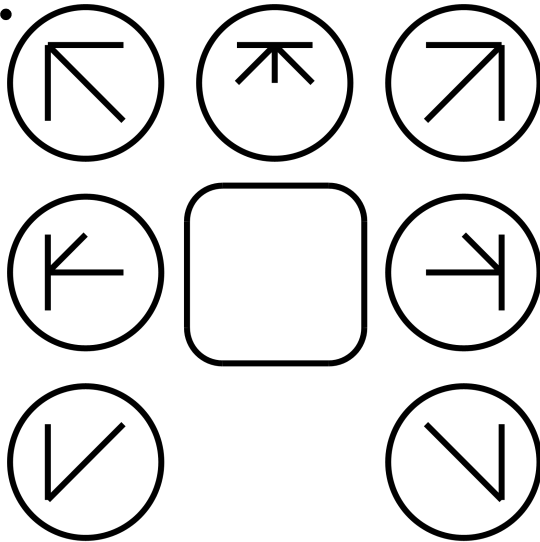

25.

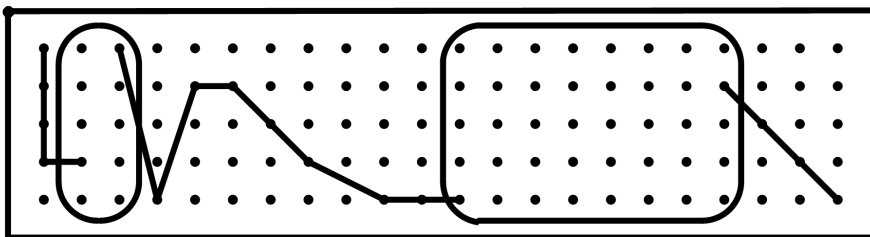

26

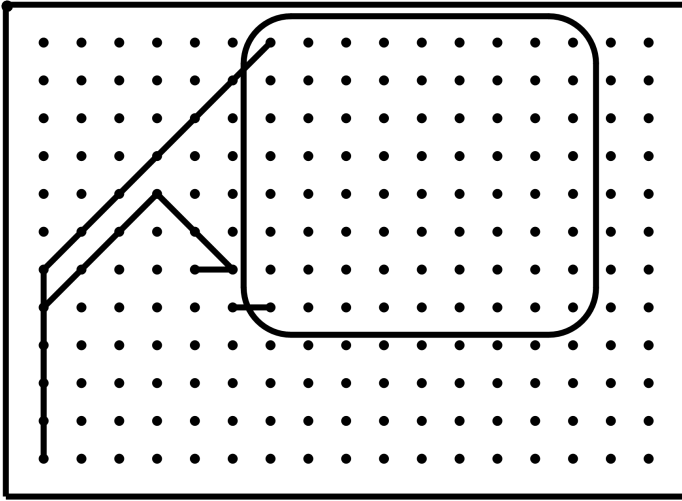

27

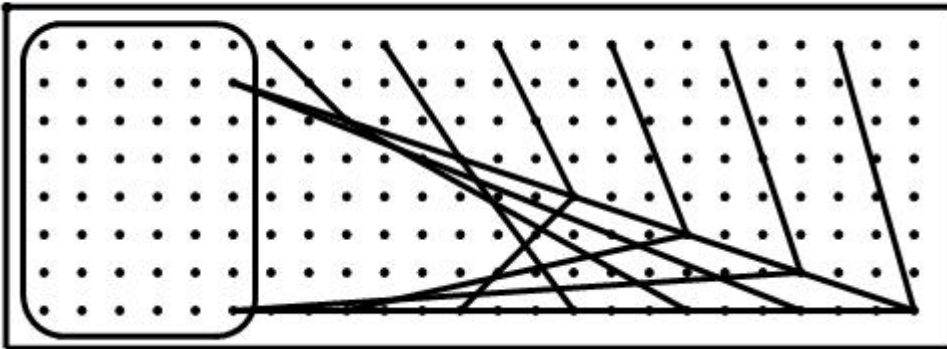

28

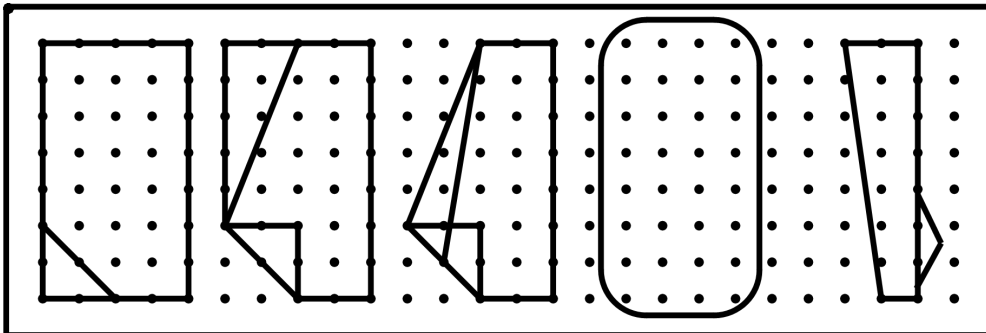

29

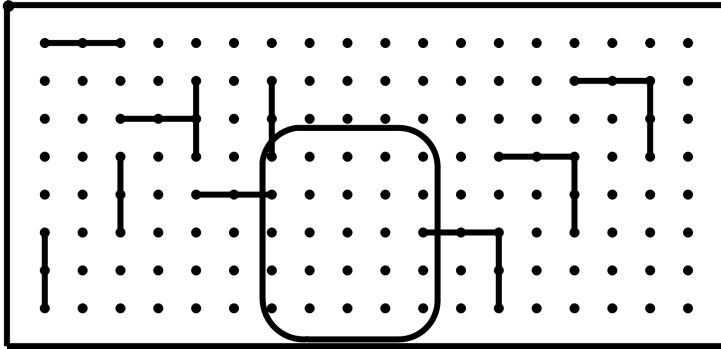

30

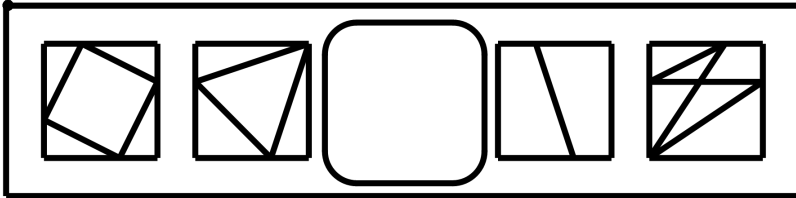

31

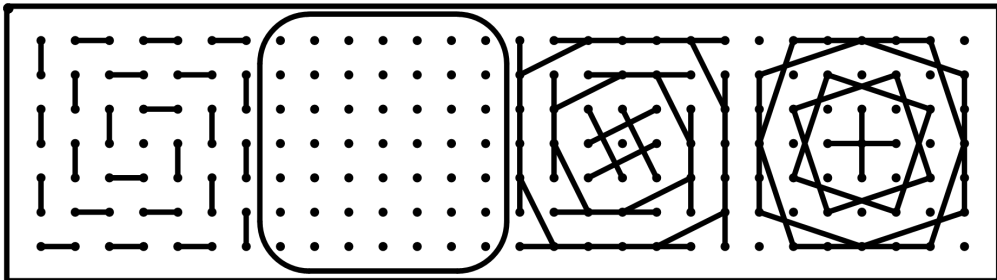

32.

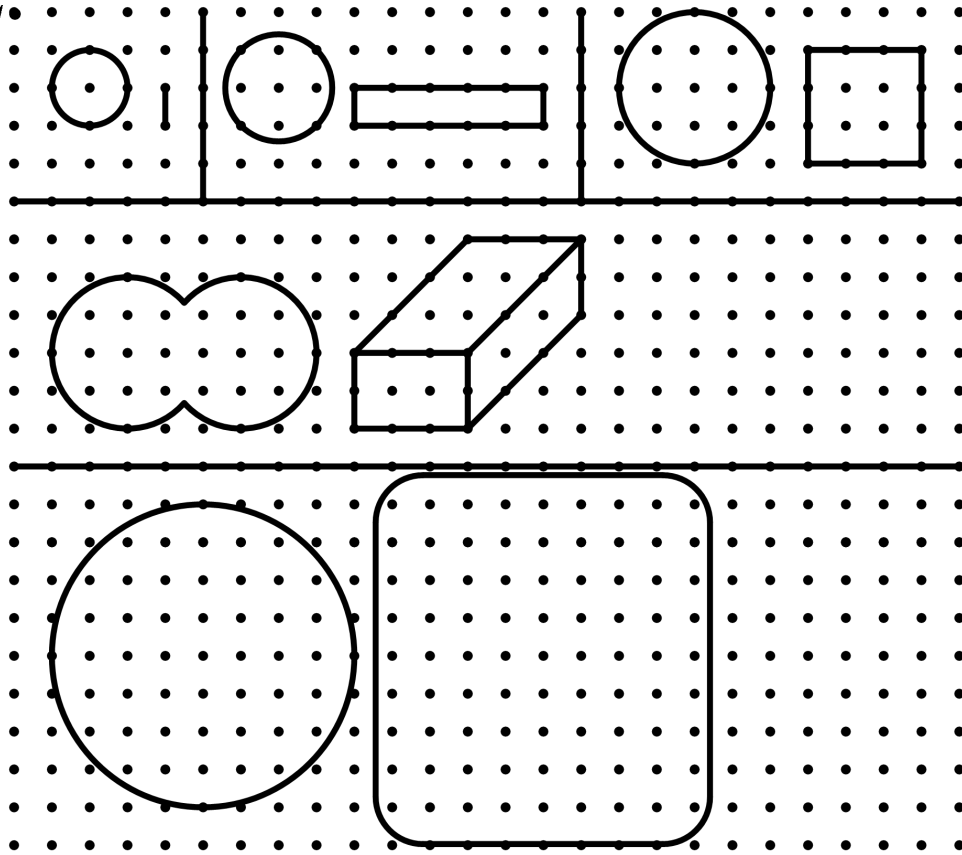

33.

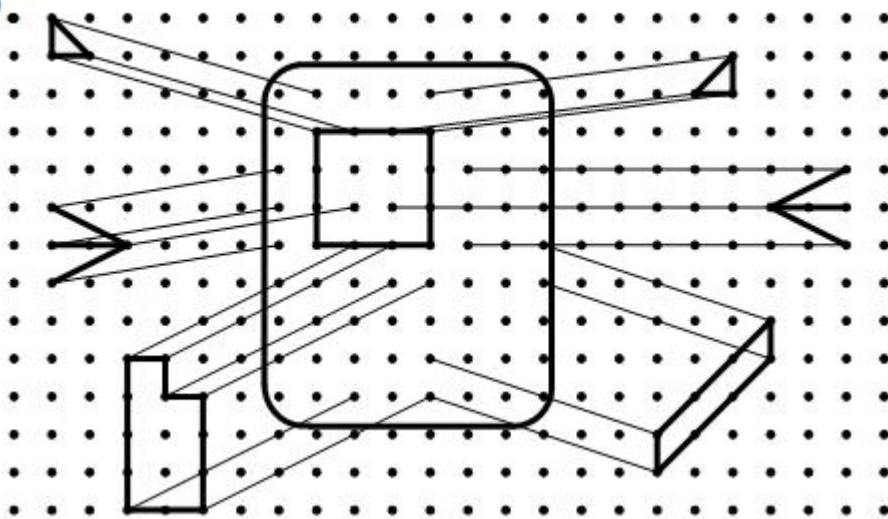

34

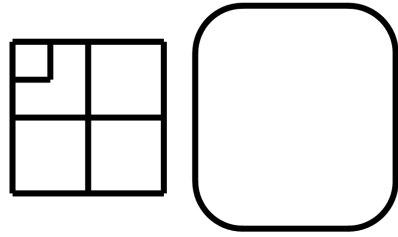
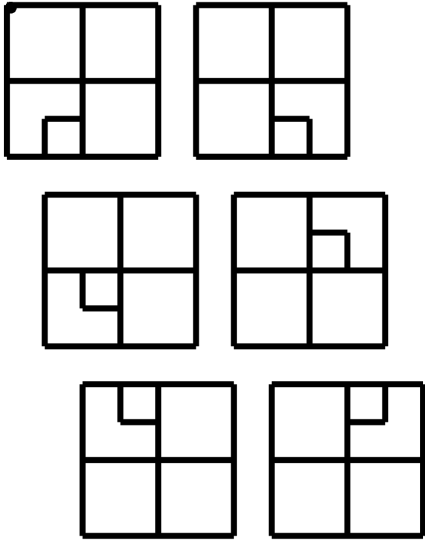

35

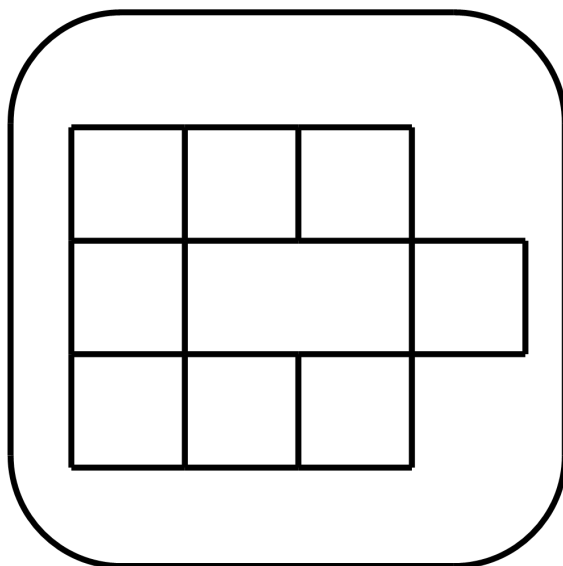
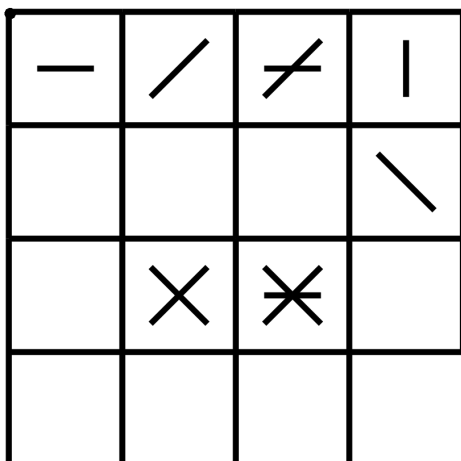

36

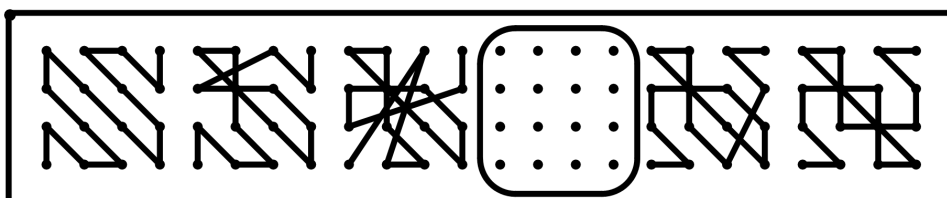

37.

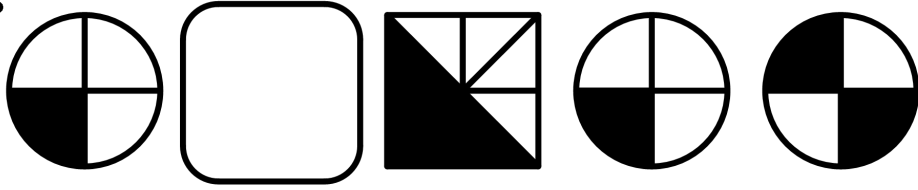

38

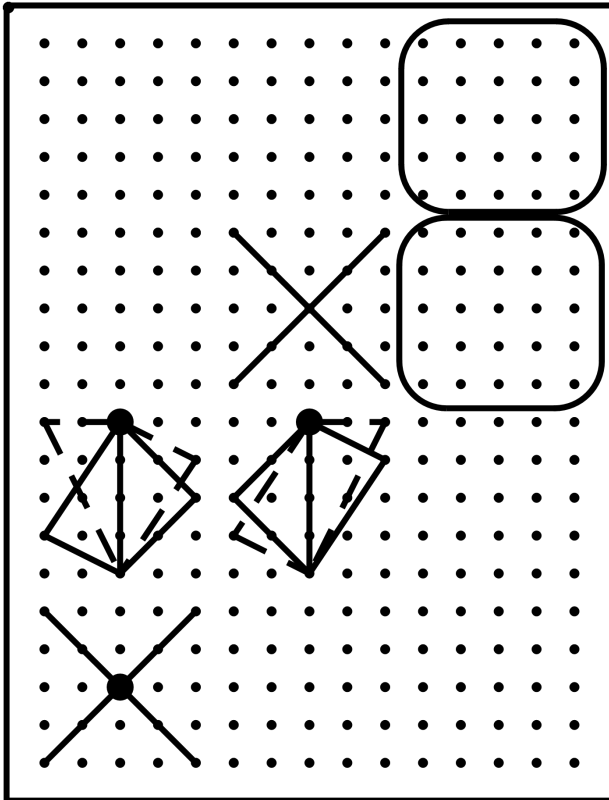

CAT Fourth Statistical Report

(12/11/2019)

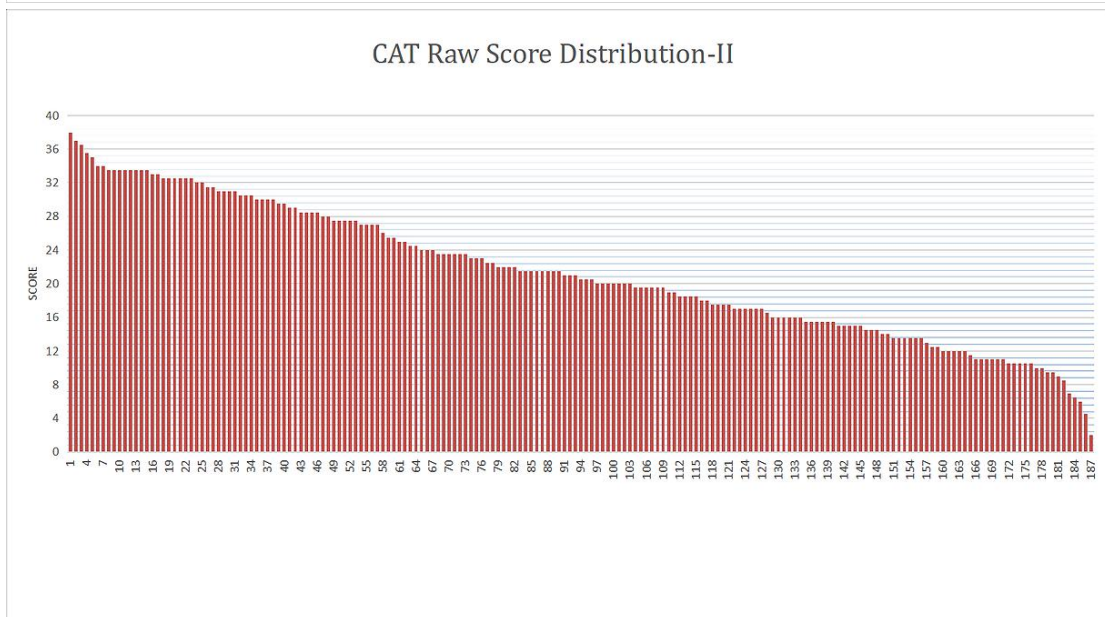
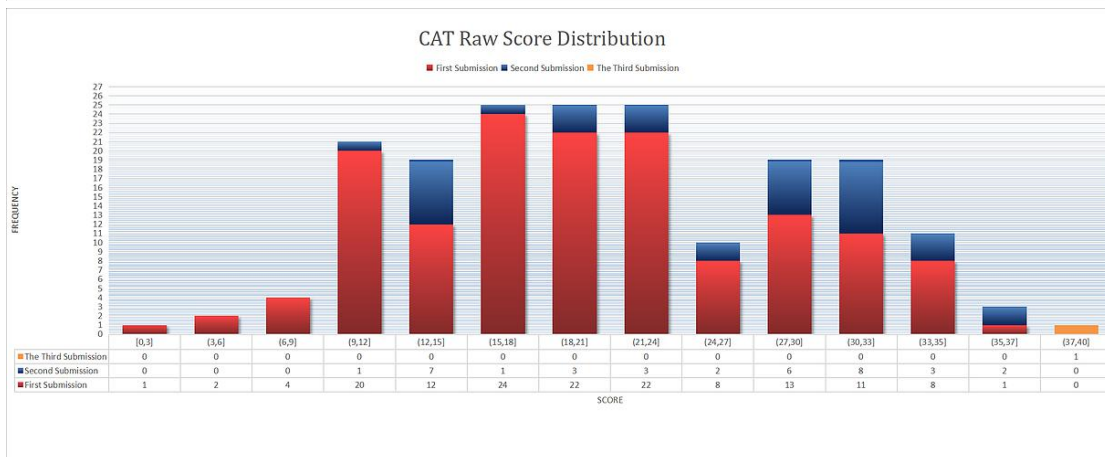
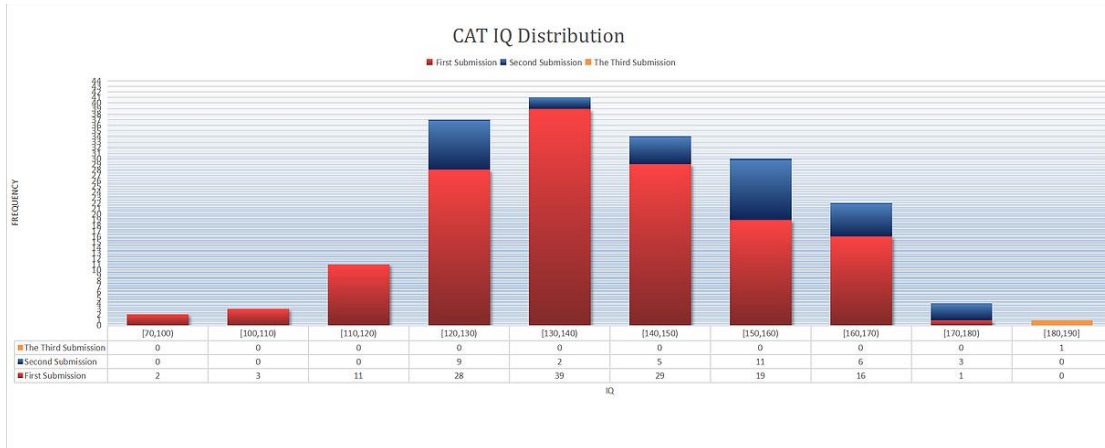

CAT Accuracy Distribution

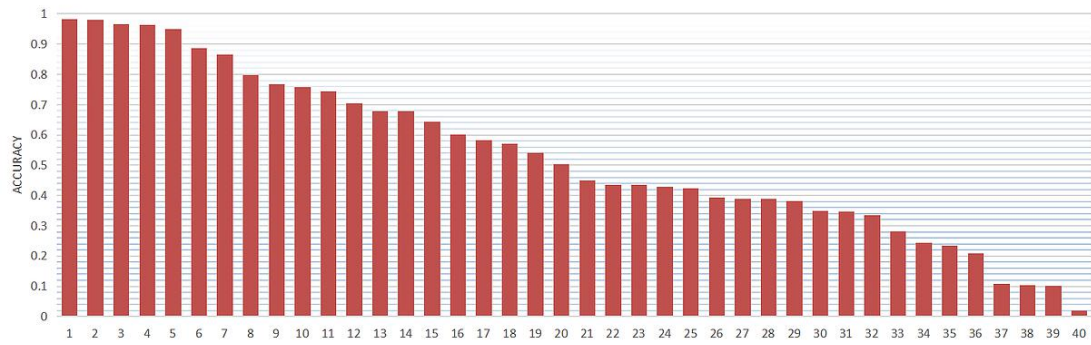

Statistical Properties		
Items	40	
Difficulty	0.469	
Good items	29	
Average items	7	
Suspicious items	3	
Bad items	1	
Unsolved items	0	
Overall quality	0.760	
Stdev	7.918	
Variance	62.700	
Kurtosis	-0.868	
Skewness	0.117	
SEM	0.649	
Cronbach's alpha	0.917	
	First Attempt	All
N	149	149+37+1
Max	35.5	38
Min	2	2
Mean	20.2	21.3
Median	19.75	20.5
Quartile deviation	11.125	12.75
130 Probability	0.698	0.717
145 Probability	0.322	0.390
160 Probability	0.114	0.144
175 Probability	0.007	0.027

Estimate Accuracy(EA)*		
Raw Score	N	EA.Avg
30-40	31	0.96
20-29	49	0.89
10-19	62	0.81
0-9	7	0.53
*:Real score/Estimate score		

CAT Fourth Official Norm

N=149+37+1 Cronbach α =0.917

Raw Score	IQ(SD=15) Cronbach α =0.917	Score List
0.5	70	
1	75	
1.5	80	
2	85	x
2.5	90	
3	92	
3.5	94	
4	96	
4.5	98	x
5	100	
5.5	101	
6	103	x
6.5	105	x
7	106	x
7.5	108	
8	110	
8.5	112	x
9	114	x
9.5	115	xx
10	117	xx
10.5	119	xxxxx
11	120	xxxxxo
11.5	121	x
12	122	xxxxx
12.5	123	xx
13	124	x
13.5	125	xxxxxo
14	126	xo
14.5	127	xxo
15	128	xoooo
15.5	129	xxxxxo
16	130	xxxxxx
16.5	131	x
17	132	xxxxxx
17.5	133	xxxx
18	134	xx
18.5	135	xxxx
19	136	xx
19.5	137	xxxxxo
20	138	xxxxxxo
20.5	139	xxx
21	140	xxo
21.5	141	xxxxxxo
22	142	xxxo
22.5	143	xx
23	144	xxx
23.5	145	xxxxxo
24	146	xxx
24.5	146.5	xo
25	147	xx
25.5	148	xo
26	149	x
26.5	150	
27	151	xxxo
27.5	152	xxxxxo
28	153	xx
28.5	154	xxxo
29	155	xo
29.5	156	oo
30	157	xxxo
30.5	158	xoo
31	159	xxoo
31.5	160	xo
32	162	xx
32.5	164	xxxxxo
33	165	xo
33.5	166	xxxxxxo
34	167	xx
34.5	169	
35	170	o
35.5	172	x
36	174	
36.5	176	o
37	178	o
37.5	180	
38	182	*
38.5	184	
39	186	
39.5	188	
40	>190	

CAT 专用答题纸

